

5V-Crimp Installation Manual

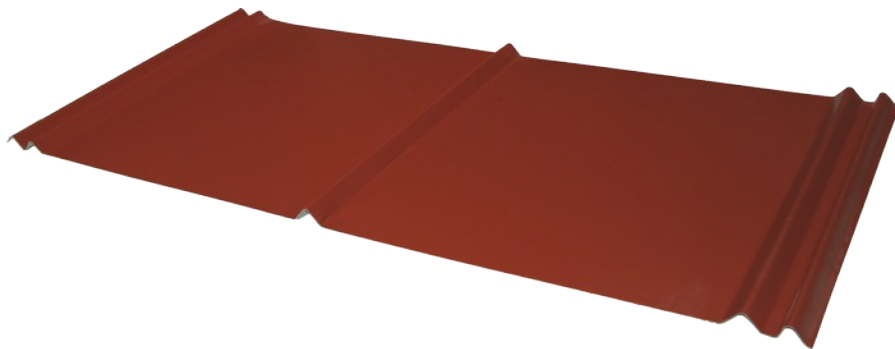

“Nationwide supplier of quality metal roofing.”



1652 S. Lee Hwy.
Cleveland, TN 37311

● www.bestbuymetals.com ●

Toll-Free
(800) 728-4010

IMPORTANT NOTICE

This manual contains suggestions and guidelines on how to install Best Buy Metals panels and trim details. The contents of this manual include the guidelines that were in effect at the time this publication was originally printed. In an effort to keep pace with the ever-changing code environment, Best Buy Metals retains the right to change specifications and / or designs at any time without incurring any obligations. To insure you have the latest information available, please inquire or visit our web site. Application and design details are for illustrative purposes only and may not be appropriate for all environmental conditions and/or building designs. Projects should be engineered and installed to conform to applicable building codes, regulations, and accepted industry practices.

TABLE OF CONTENTS

1. Introduction - Design and Testing	Page	3
2. Panel Installation		
a. Installation Guide	Pages	4, 5
b. Panel Squaring	Pages	6, 7
3. Installation Sequence	Pages	8, 9
4. Trim Assemblies		
a. Fascia	Page	10
b. Mini Eave	Page	11
c. Eave Trim	Page	12
d. Rake / Gable	Page	13
e. Preformed Valley	Page	14
f.	Page	15
	Page	16
h. Hip	Page	17
i. Ridge	Page	18
j. Vented Ridge	Page	19
k. High Side Peak	Page	20
l. Side Wall	Page	21
m. End Wall	Page	22
5. Trim, Accessories, & Tools	Pages	23, 24, 25
6. Special Details		
a. Valley Lapping and Cutting		
b. Pipe Flashing	Page	26, 27

Introduction

The 5V-Crimp panel is one of the original metal roofing panels that gained nationwide popularity. This popular and versatile panel features classic looks and is used in a wide range of applications including residential, commercial, and post-frame buildings. 5V-Crimp is known for its classic double “v” design, providing strength and weather tightness.

5V-Crimp is available in many different paint colors and in both 26 and 29 gauge steel. It is also available in unpainted Galvalume® or in some cases unpainted galvanized. Our paint system and Galvalume® substrate are individually covered by a limited warranty. Please see our color chart for details on our paint system.

The 5V-Crimp panel is available in a 24” coverage. The panel has five major support ribs at 1/2” high that add rigidity and strength to the panel.

5V-Crimp is Metal Construction Association certified. Below is a list of all of the 5V-Crimp panels approvals and certifications.

- Dade County NOA #07-1114.01
- Florida Building Code Approval #FL7271.1, #FL9610.1
#FL7765.1, #FL6895.2, #FL4586.1
- Texas Department of Insurance Approval #119
- UL 790 Fire Resistance Class 4
- UL 2218 Impact Resistance Class 4
- UL 580 Uplift UL Class 90 CONSTRUCTION #579

Allowable Uniform Loads Per Square Foot

Maximum purlin spacing for roof 2’ on center and maximum girt spacing for sidewall 3’ on center. Place fasteners in the pan of panel for best results. (Three spans or more)

SPAN (INCHES)	LIVE LOAD (lb/ft ²)							WIND LOAD (lb/ft ²)						
	12"	15"	18"	21"	24"	30"	36"	12"	15"	18"	21"	24"	30"	36"
29 Gauge	146	93	64	47	36	23	16	200	128	89	65	50	32	22
26 Gauge	200	128	89	65	50	32	22	267	170	118	87	66	42	29

NOTES:

1. Theoretical allowable loads are based on section properties and allowables calculated in accordance with 2001 AISI Specifications.
2. Theoretical allowable loads are based on three or more uniform spans.
3. For roof panels, deduct self weight for actual ‘live load’ capacity of the panel.
4. These loads are for panel strength. Frames, purlins, decks and fasteners must be designed to resist all loads imposed on the panel.
5. Check local building codes if panel testing is required.

Panel Installation Guide

Storage

If metal is not to be used immediately, store inside in a well ventilated, dry location. Condensation or other moisture can form between the sheets during storage causing water stains or white rust which detract from the appearance of the product and may affect the product's useful life. Trapped moisture between sheets of painted metal can cause white rust to form underneath the paint. This can cause the paint to flake off the panel immediately or several years later. To prevent white rust and staining, break the shipping bands on the material. Store the material on end or on an incline of at least 8" with a supporting board underneath to prevent sagging. Fan the sheets slightly at the bottom to allow for air circulation. Keep the sheets off of the ground with an insulator such as wood. Any outdoor storage is at the customer's own risk. If outdoor storage cannot be avoided, protect the metal using a canvas cover or waterproof paper. Never cover the metal with plastic as this will cause condensation to form.

Some Safety Precautions

Always wear protective gloves when working with steel panels to avoid cuts from sharp edges. When cutting or drilling steel panels, always wear safety glasses and sweep off any metal shavings immediately to prevent eye injury from flying metal fragments. If you must walk on a metal roof, take great care. Metal panels can become slippery, so always wear shoes with non-slip soles. Avoid working on metal roofs during wet conditions when the panels can become extremely slippery.

General Installation Information

Insure that the structure is square and true before beginning panel installation. If the structure is not square, the panels will not properly seal at the sidelaps. Start the first panel square to eave by using the 3, 4, 5 Triangle Method. Green or damp lumber is not recommended. Moisture released from the damp lumber may damage the metal panels. Nails installed in green or damp lumber may back out. Remove any loose metal shavings left on the roof surface immediately to prevent corrosion. After installing roof, remove any debris such as leaves or dirt to prevent moisture from getting trapped on panels.

Fastening

If you wish to predrill fastener holes, use a cover sheet to prevent hot shavings from sticking to panels. Screws - For best results, use a 1-1/2" washered wood screw in the flat of the panel as shown in the illustration below. Drive the fastener so that the washer is compressed securely against the metal. Do not over drive the fastener as this will form a dimple that can collect water and cause leakage. Do not leave any loose fasteners that have missed the purlin. Use a #14 stitch screw or caulk to fill the hole.

Figure #1 - Fastening Patterns for 5V-Crimp

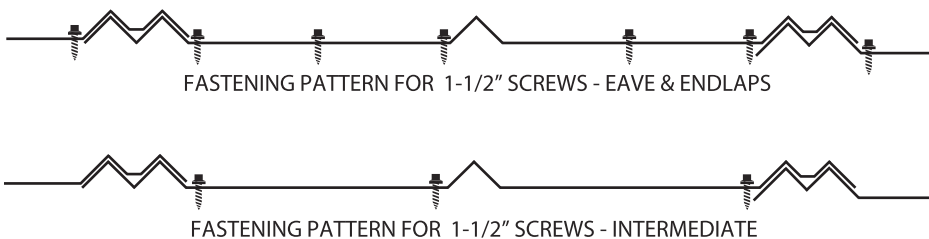
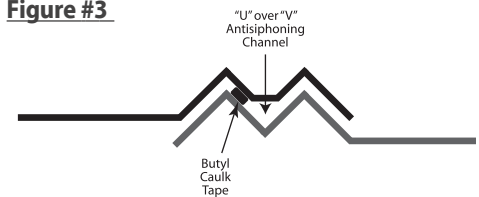

Figure #3



Roofing

Slopes of less than 2.5" on 12" are not recommended. For slopes of 2.5" on 12" or greater, end lap panels 6". Side laps should face away from the prevailing wind. Lay the first sheet along the eave at the down-wind side of the roof, farthest away from the direction of the prevailing winds (See Figure #4). Install sheets in the sequence shown in Figure #4.

Figure #4

Sheet Installation Pattern

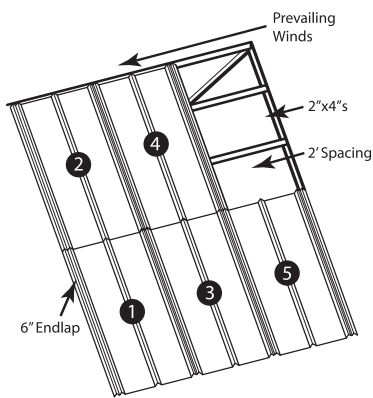
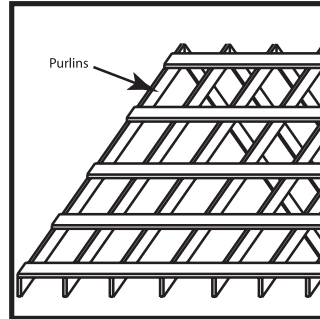

Figure #5 - Installation Options

Option 1



Wood Frame

- Use Maximum 2' Purlin Spacing
- Install Metal

Note: Do not use this option for heated spaces.

Option 2

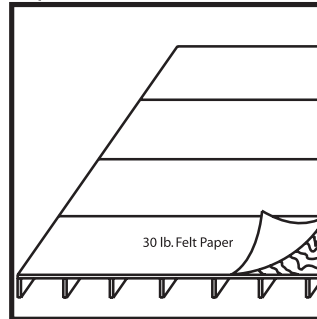

Solid Deck *

- Lay Plywood Deck
- Apply 30 lb. Felt Paper
- Install Metal

Option 3

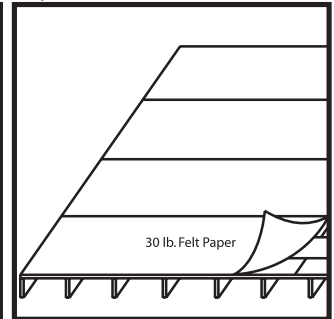

Existing Shingles *

- Apply 30 lb. Felt Paper
- Install Metal

* Proper ventilation and vapor barrier protection recommended for heated spaces.

Allow an overhang a minimum of 1" at the eave to provide for a drip edge. Use inside closure at eave to prevent water infiltration, insect or bird infestation at openings. To protect against uplifting winds and to provide a finished appearance, apply gable trim. Apply fasteners every 6"-10". Optionally apply butyl tape as shown in Figure #6 between lap ribs. Do not block the siphon channel with the tape.

Figure #6 - Proper Application of Side Lap Butyl Tape

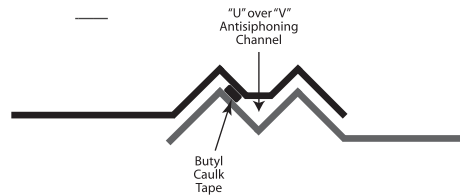

3...4...5...Triangle Method

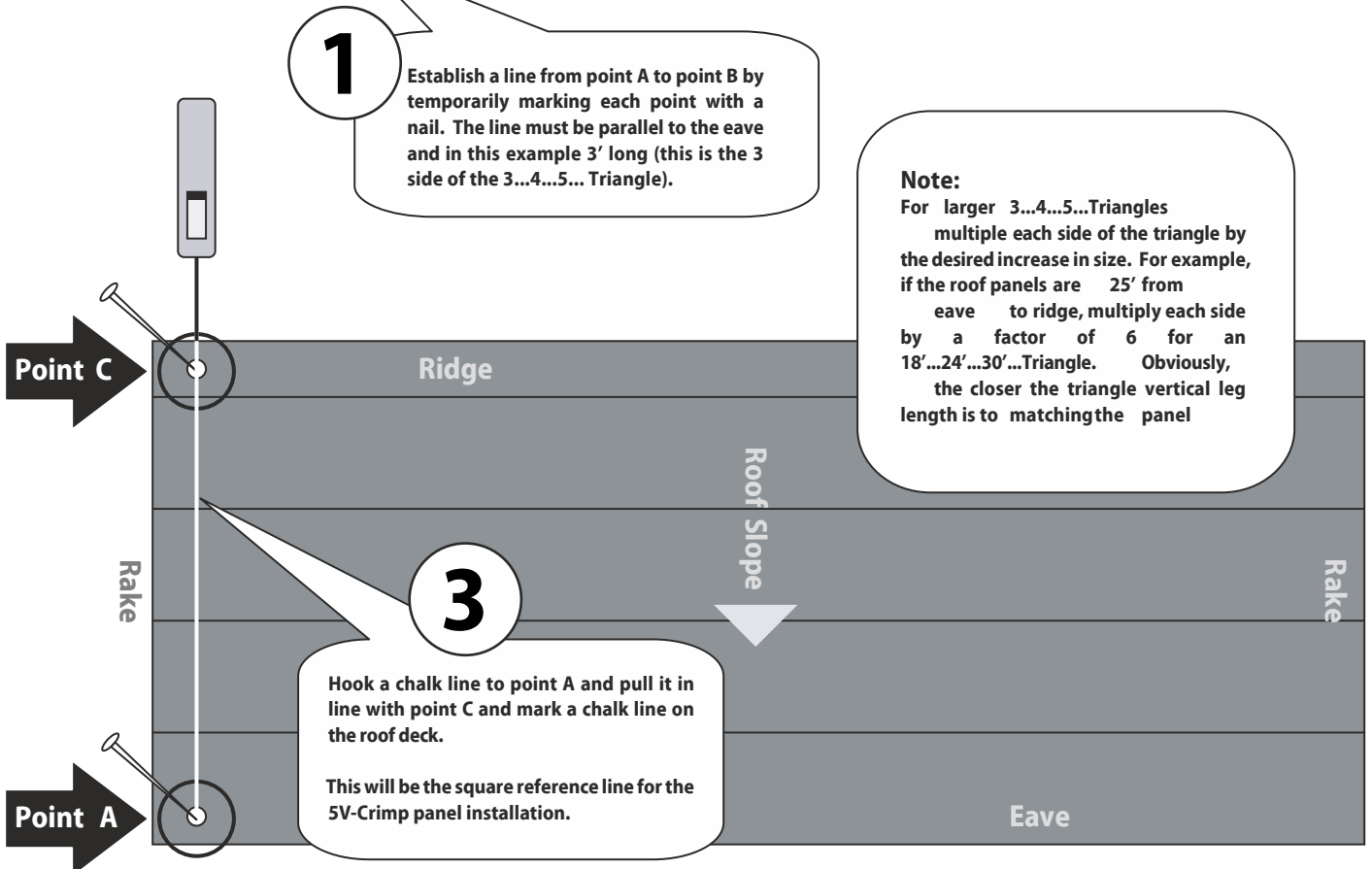
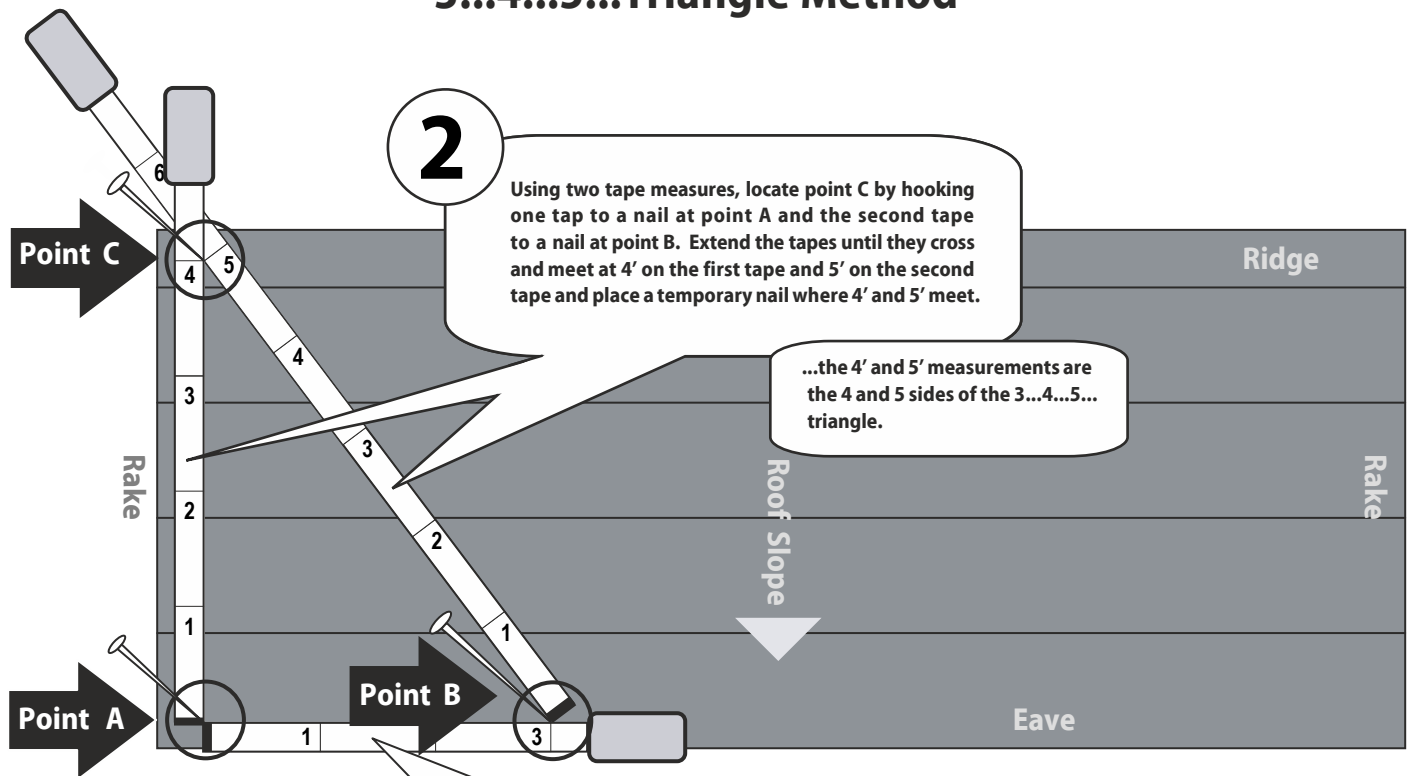

3...4...5...Triangle Method

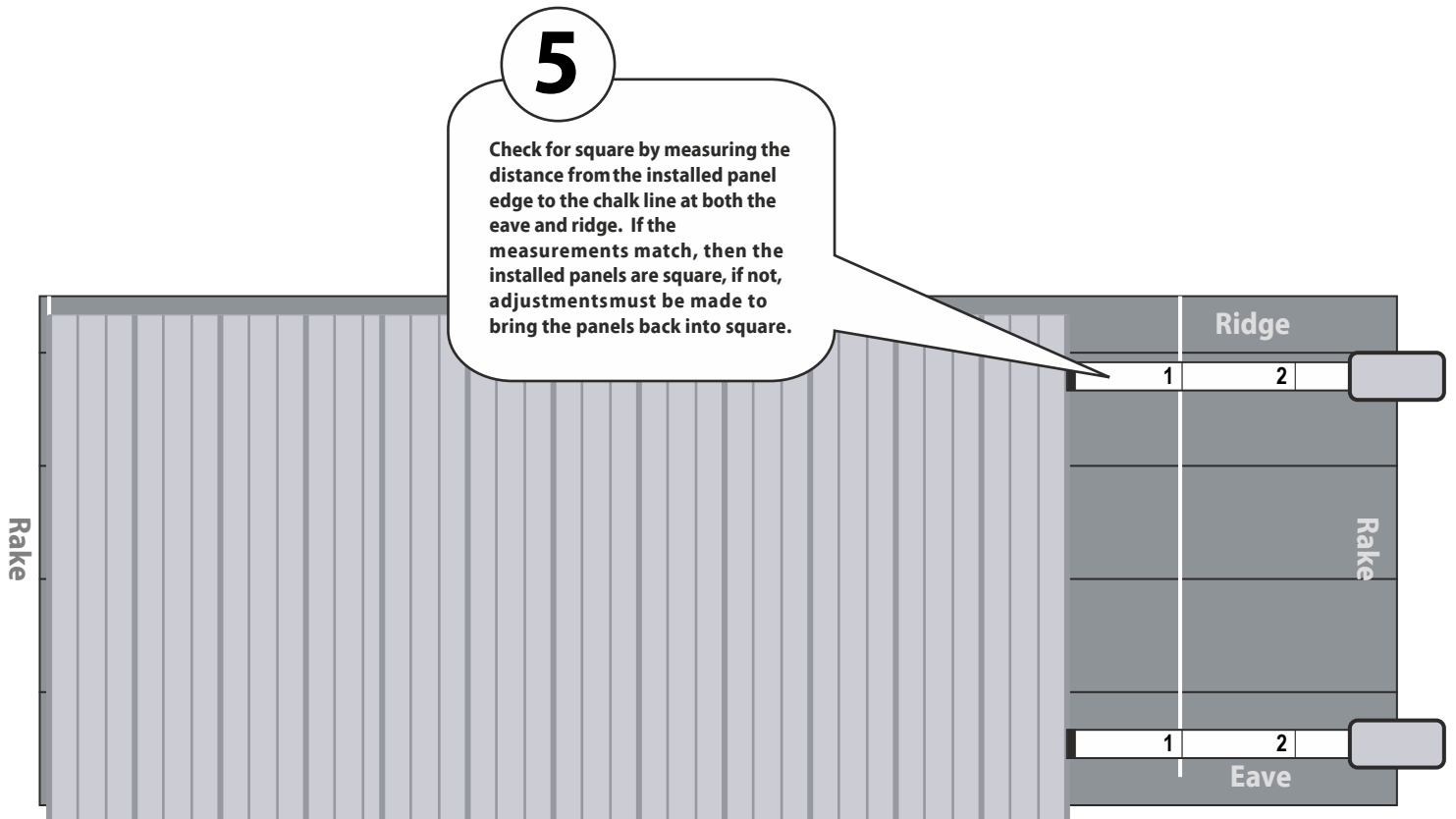
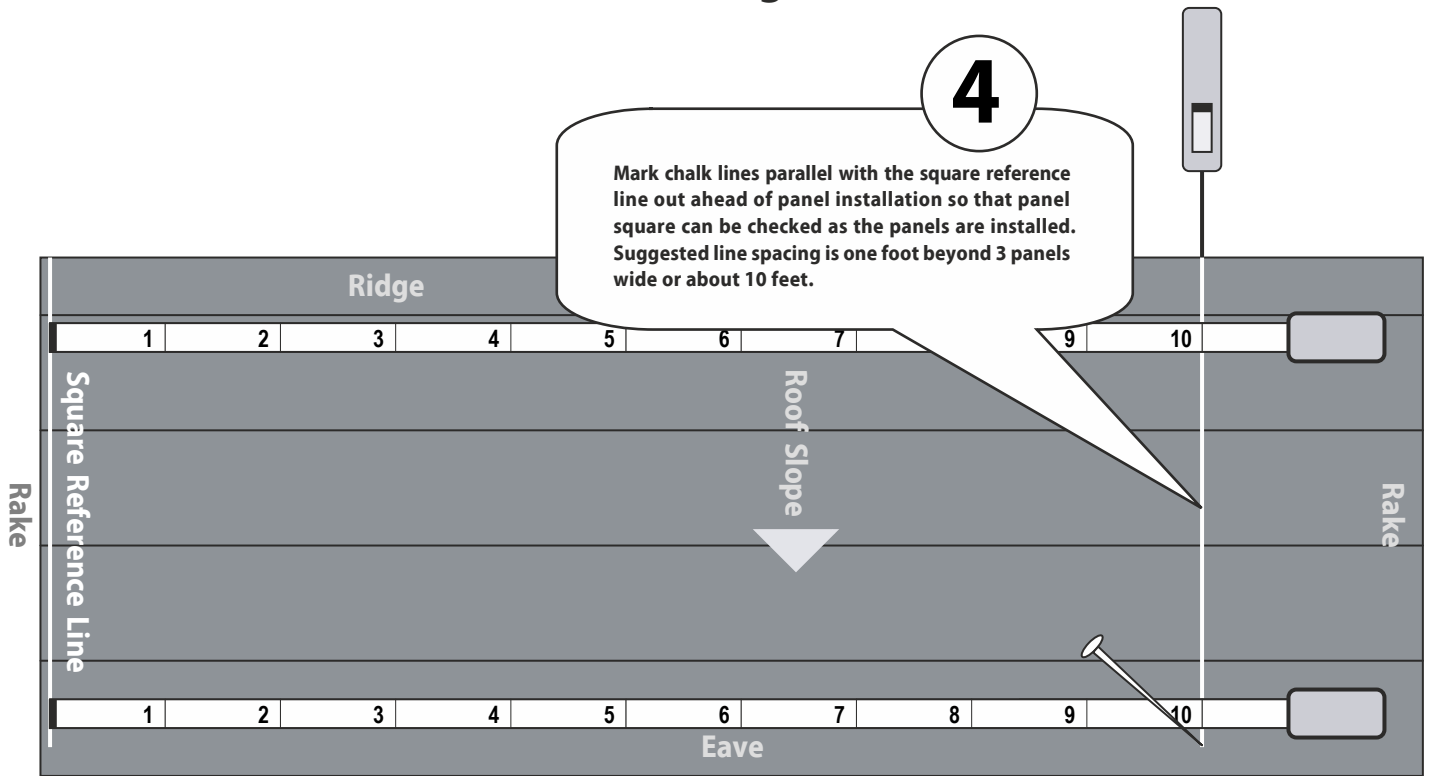

Installation Sequence

The following is an example of a typical sequence for the installation of 5V-Crimp panels and trims and is specific to the roof plan and conditions illustrated. The actual sequence may vary based on the specific roof plan and applicable conditions.

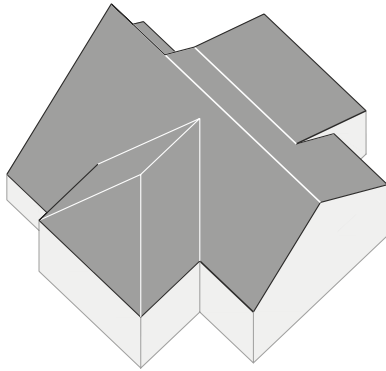

1. Moisture Barrier

Install the Moisture Barrier per the manufacturer's

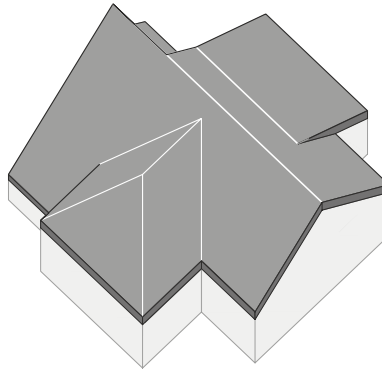

2. Fascia Trim (optional)

Install the Fascia Trim along all eaves and rakes.

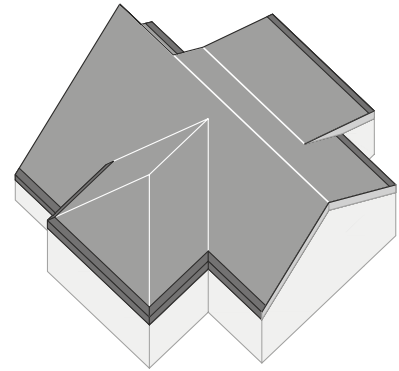

3. Eave Trim

Install the Eave Trim along all eaves lapping over the Fascia Trim.

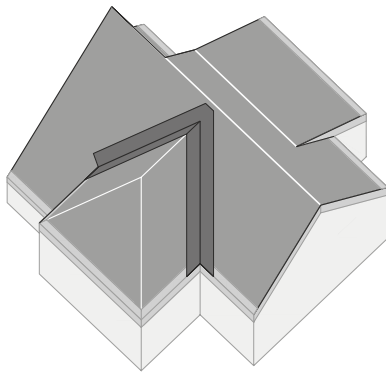

4. Valley Trim

Install the Valley Trim over the Eave Trim working from the eave to the valley peak.

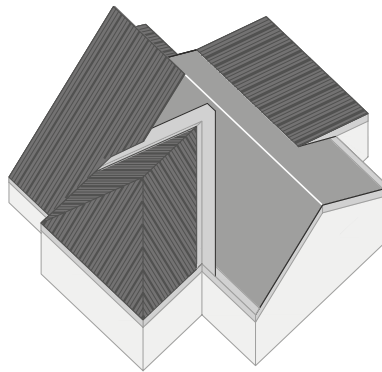

5. 5V-Crimp Panels

Install the panels over the Eave and Valley Trims. Do not install panels where the Ridge Trim laps under the panels.

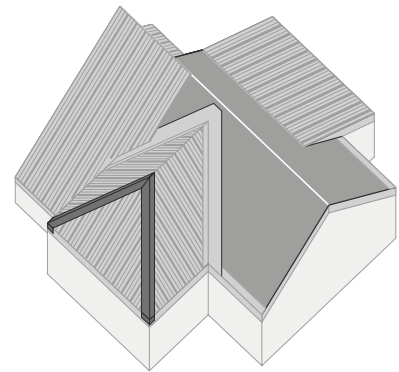

6. Hip Trim

Install the Hip Trim over the panels.

Installation Sequence

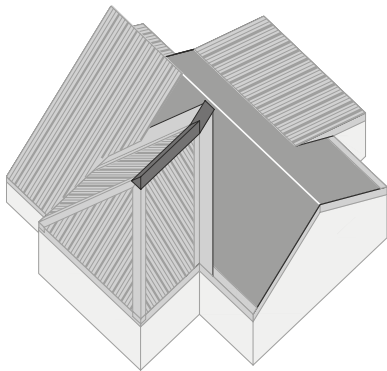

7. Ridge Trim
Install the Ridge Trim over the Hip Trim intersection and valley peak.

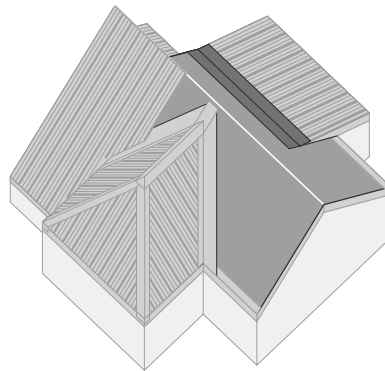

8. Transition Trim
Install the Transition Trim over the low slope panels and moisture barrier.

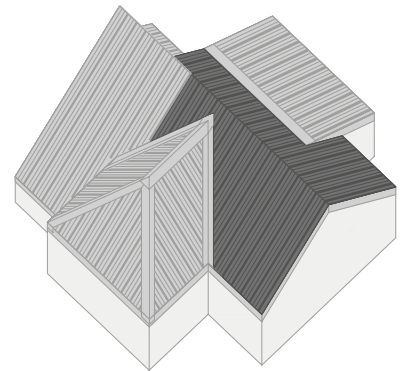

9. 5V-Crimp Panels
Complete the panel installation installing the high slope panels over the Trim Transition and the other remaining exposed locations.

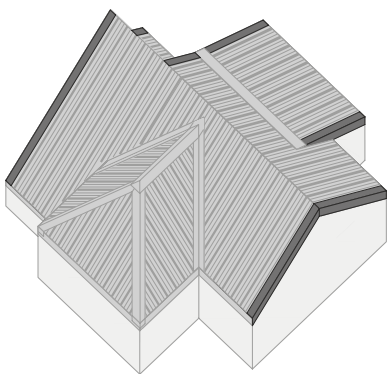

10. Gable / Rake Trim
Install the Rake Trim over the panels along all rake (gable) edges.

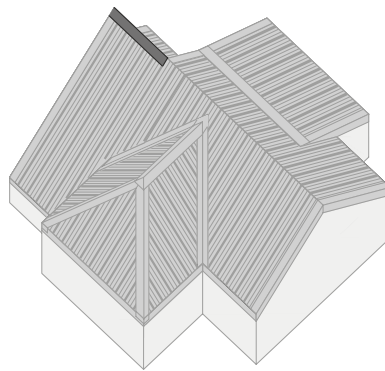

11. High Side Peak Trim
Install the High Side Peak Trim over the panels.

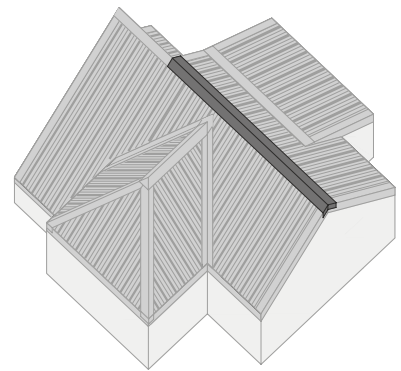

12. Ridge Trim
Install the Ridge Trim over the panels.

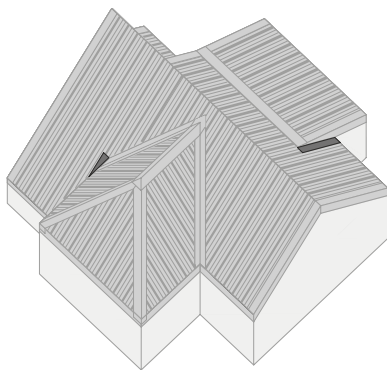

13. Side Wall Trim
Install the Side Wall Trim over the panels.

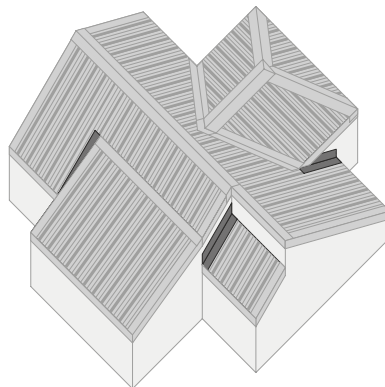

14. Side Wall Trim (Rear View)
Install the Side Wall Trim over the panels.

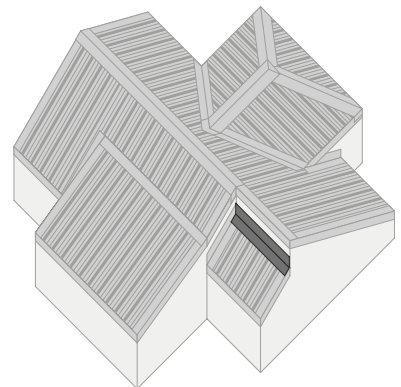

15. End Wall Trim
Install the End Wall Trim over the panels.

Fascia

Numbers indicate suggested trim assembly sequence.

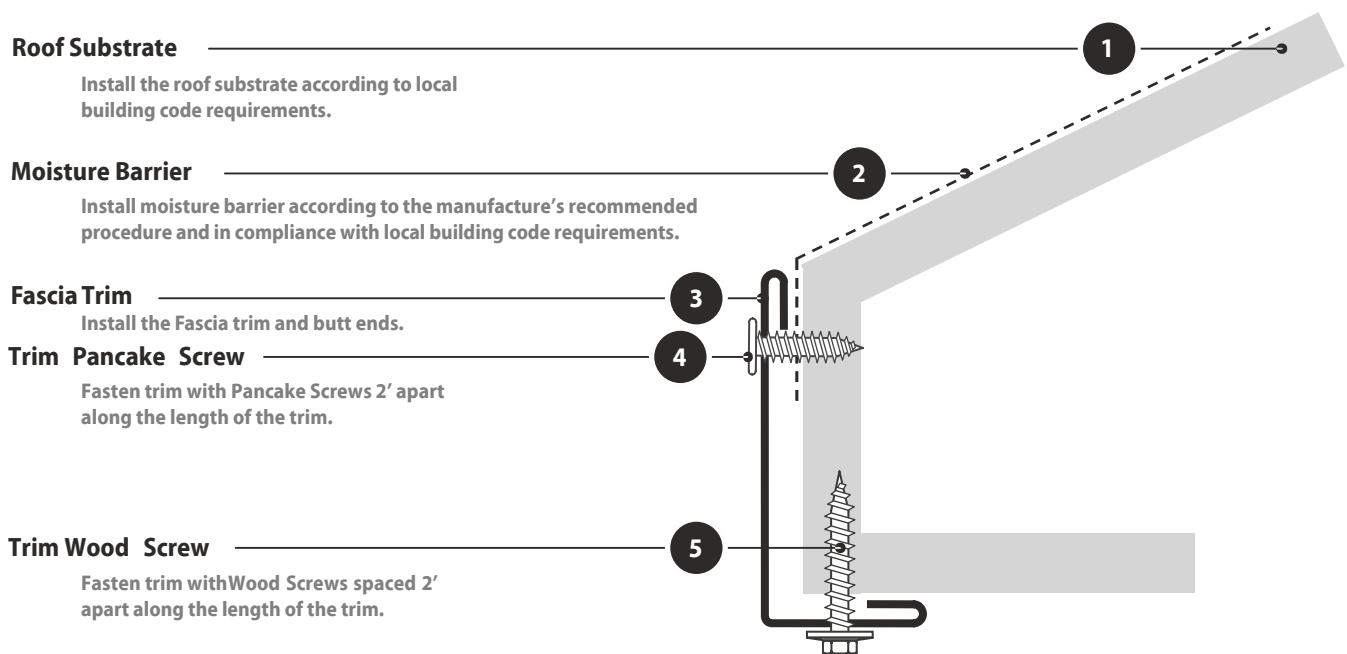
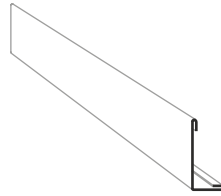

Mini Eave

Numbers indicate suggested trim assembly sequence.

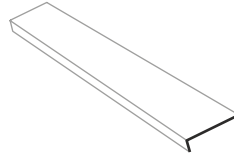

Moisture Barrier

Install moisture barrier according to the manufacturer's recommended procedure and in compliance with local building code requirements.

2

Trim Pancake Screw

Fasten trim with Pancake Screws spaced 2' apart along the length of the trim.

4

Mini Style Eave

Install the Mini Style Eave and butt ends.

3

Roof Substrate

Install the roof substrate according to local building code requirements.

1

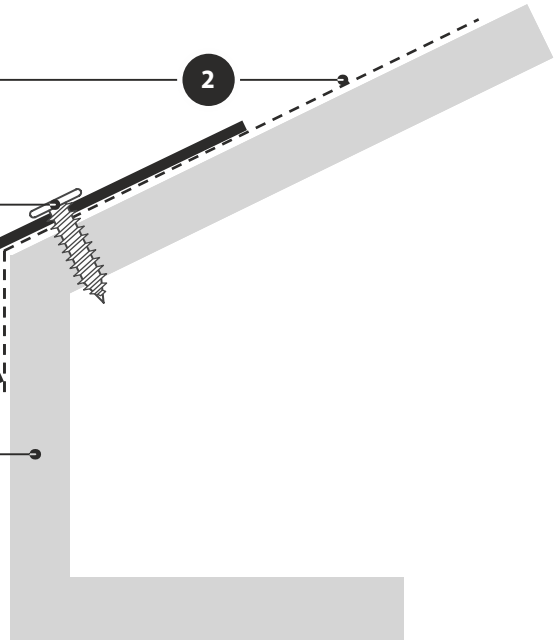

Panel Wood Screw

Fasten panels to the roof substrate using Wood Screws spaced according to the recommended fastening pattern and frequency, and in compliance with local building codes.

7

5V-Crimp Panel

Install the panel and overhang the panel a minimum of 1" beyond the Mini Eave trim edge. See panel squaring method in this manual.

6

Inside Closure

Place the Inside Closure over the top of the Mini Eave or underlayment.

5

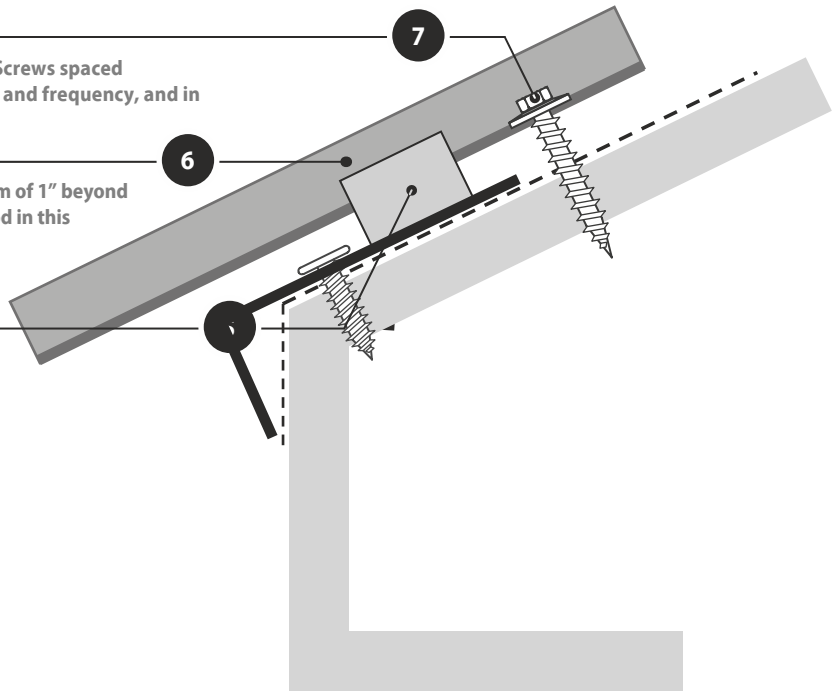

Eave Trim

Numbers indicate suggested trim assembly sequence.

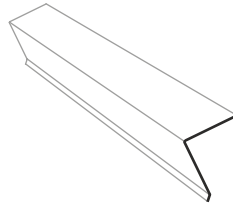

Moisture Barrier

Install moisture barrier according to the manufacturer's recommended procedure and in compliance with local building code requirements.

Trim Pancake Screw

Fasten trim with Pancake Screws spaced 2' apart along the length of the trim.

Eave Trim

Install the Eave Trim and butt ends.

Roof Substrate

Install the roof substrate according to local building code requirements.

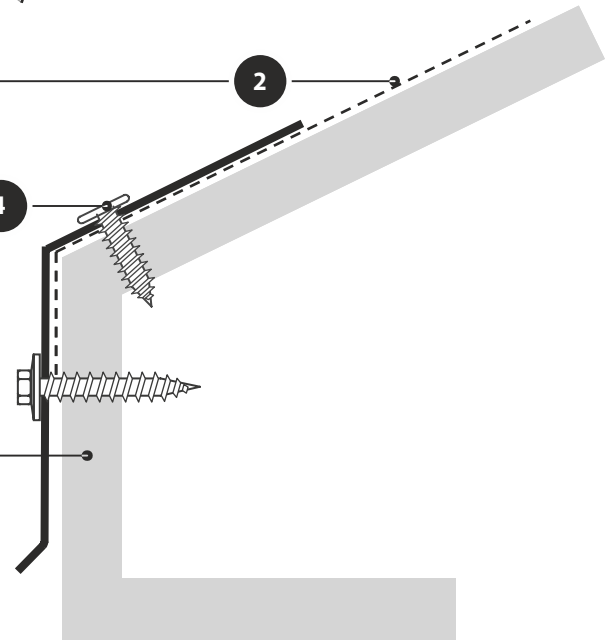

Panel Wood Screw

Fasten panels to the roof substrate using Wood Screws spaced according to the recommended fastening pattern and frequency, and in compliance with local building codes.

5V-Crimp Panel

Install the panel and overhang the panel a minimum of 1" beyond the Eave Trim edge. See panel squaring method in this manual.

Inside Closure

Place the Inside Closure down over the eave or underlayment.

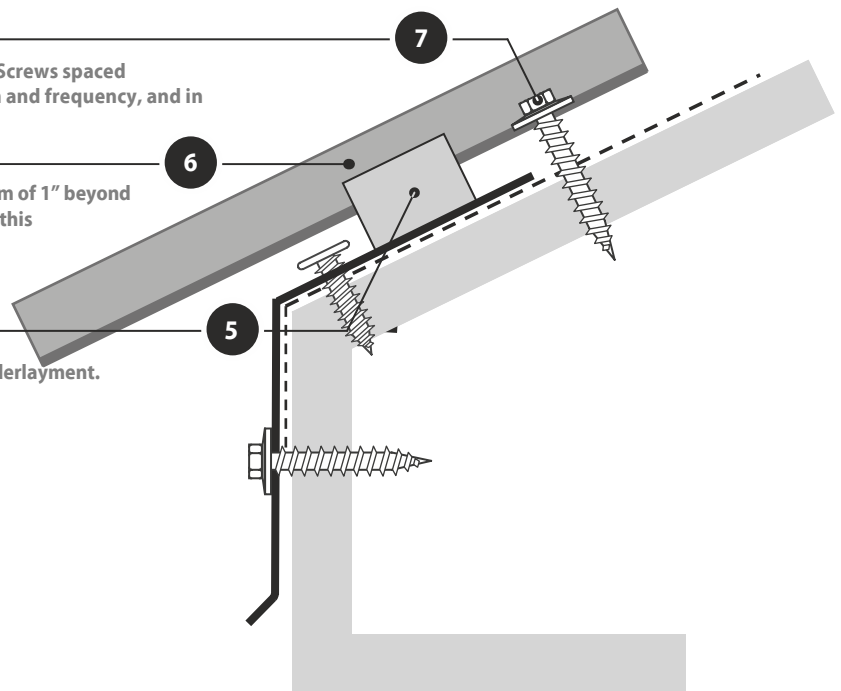

Rake / Gable

Numbers indicate suggested trim assembly sequence.

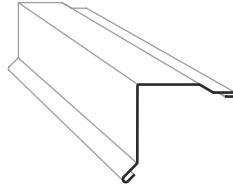

Tape Sealant

Apply Butyl Tape along the length of the panel.

5V-Crimp Panel

Install the panel and overhang the panel a minimum of 1" beyond the Eave trim edge. See panel squaring method in this manual.

Panel Wood Screw

Fasten panels to the roof substrate using Wood Screws spaced according to the recommended fastening pattern and frequency, and in compliance with local building codes.

Moisture Barrier

Install moisture barrier according to the manufacture's recommended procedure and in compliance with local building code requirements.

Roof Substrate

Install the roof substrate according to local building code requirements.

Rake / Gable Trim

Install the Rake trim and overlap the ends 4". See lapping diagram in this manual.

Trim Wood Screw

Fasten trim with Wood Screws spaced 2' apart along the length of the trim.

Trim Wood Screw

Fasten trim with Wood Screws spaced 2' apart along the length of the trim.

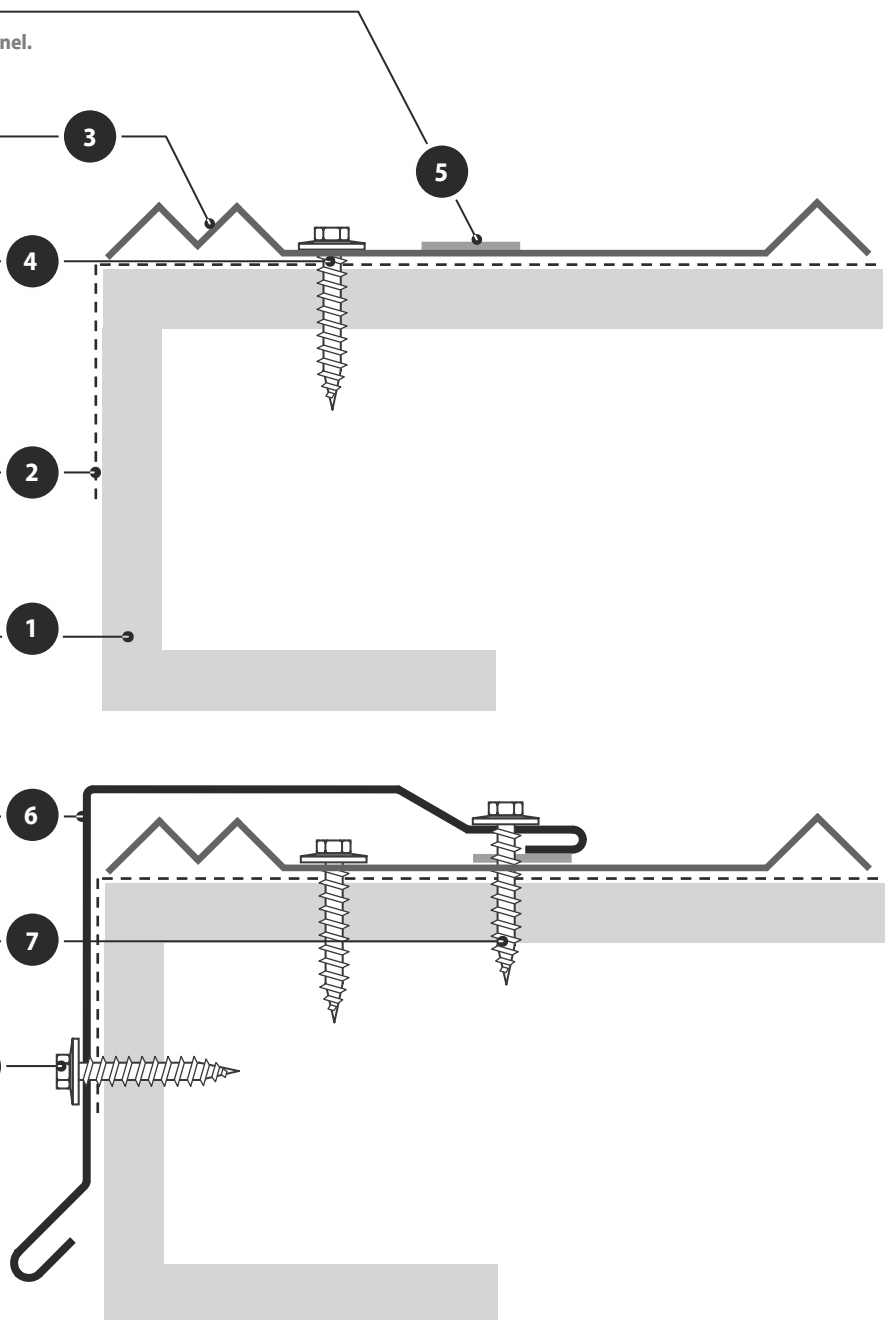

Preformed Valley

Numbers indicate suggested trim assembly sequence.

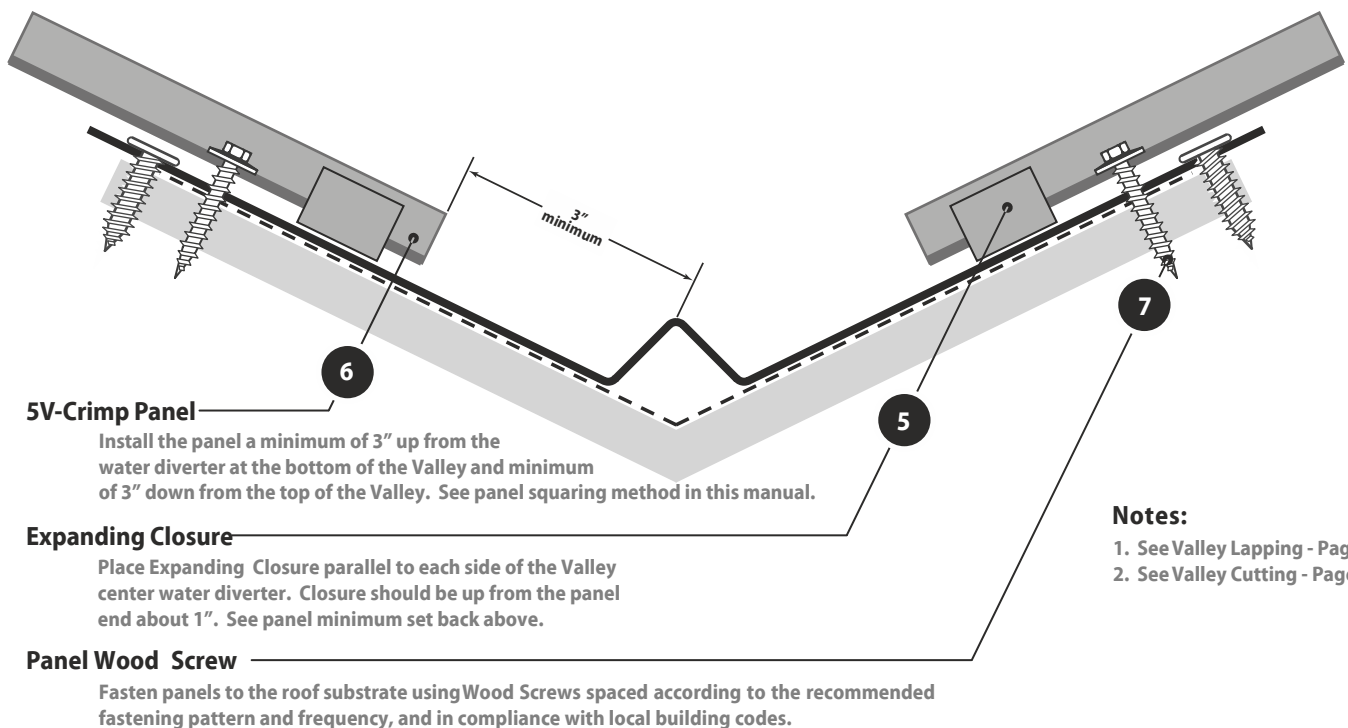
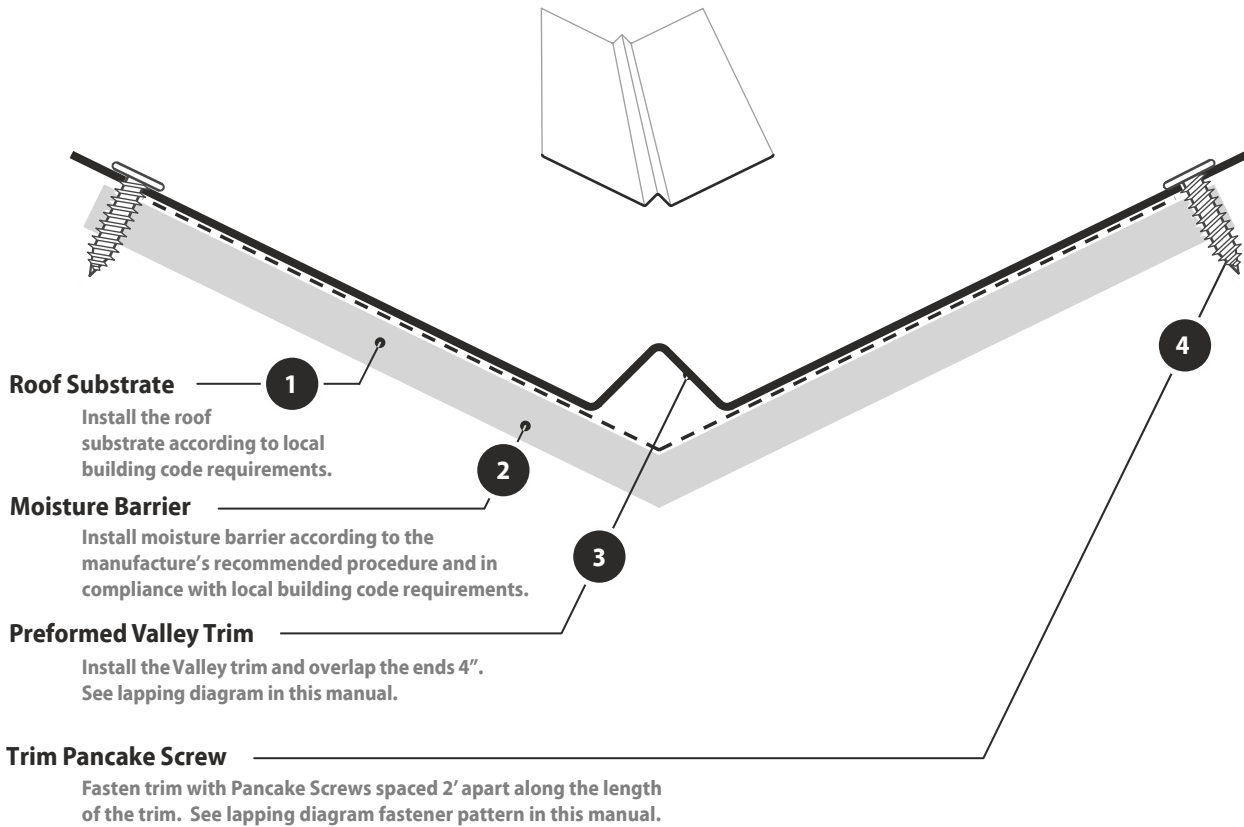

Notes:

1. See Valley Lapping - Page 25
2. See Valley Cutting - Page 26

Transition / Pitch Break

Numbers indicate suggested trim assembly sequence.

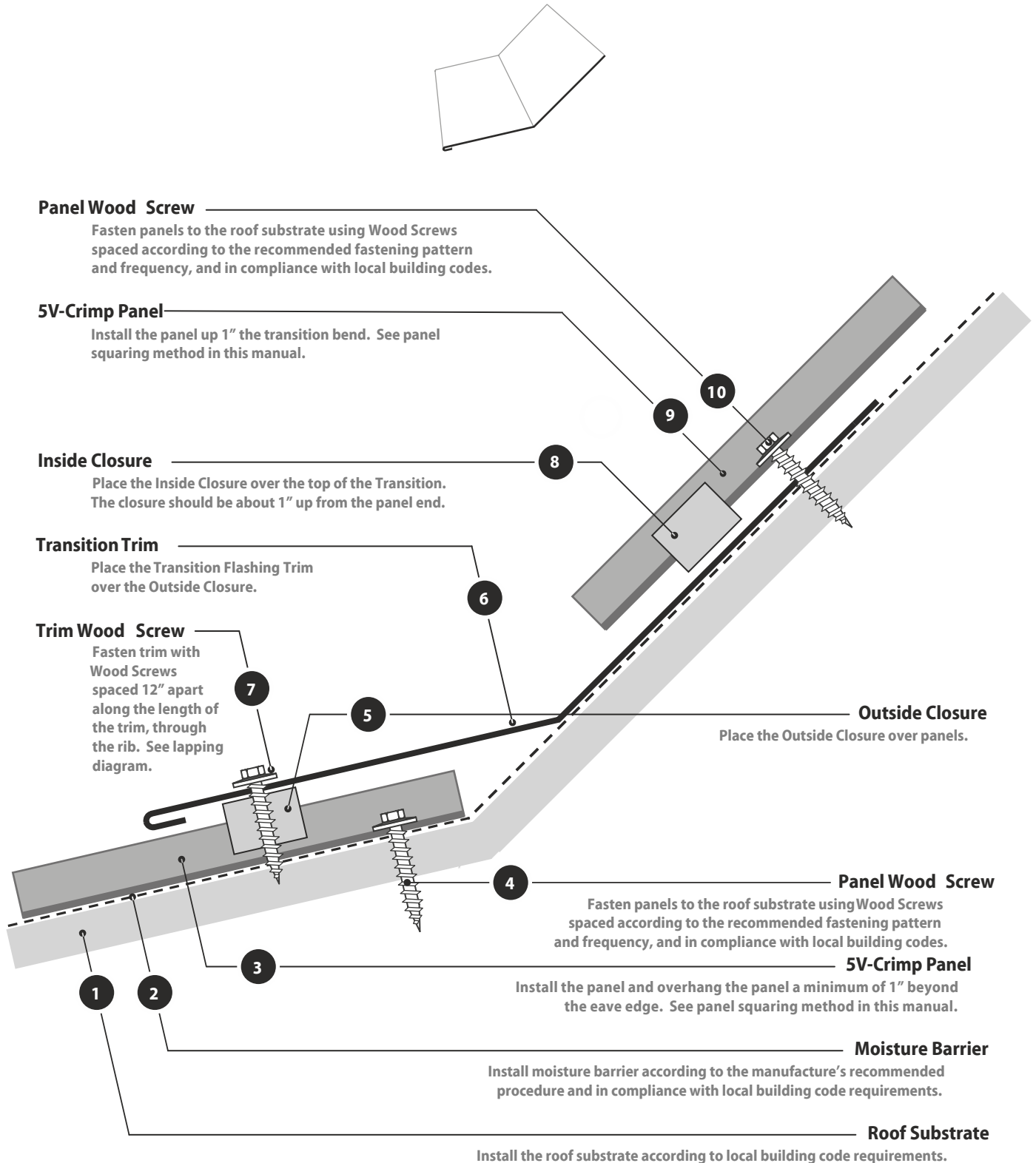

Gambrel

Numbers indicate suggested trim assembly sequence.

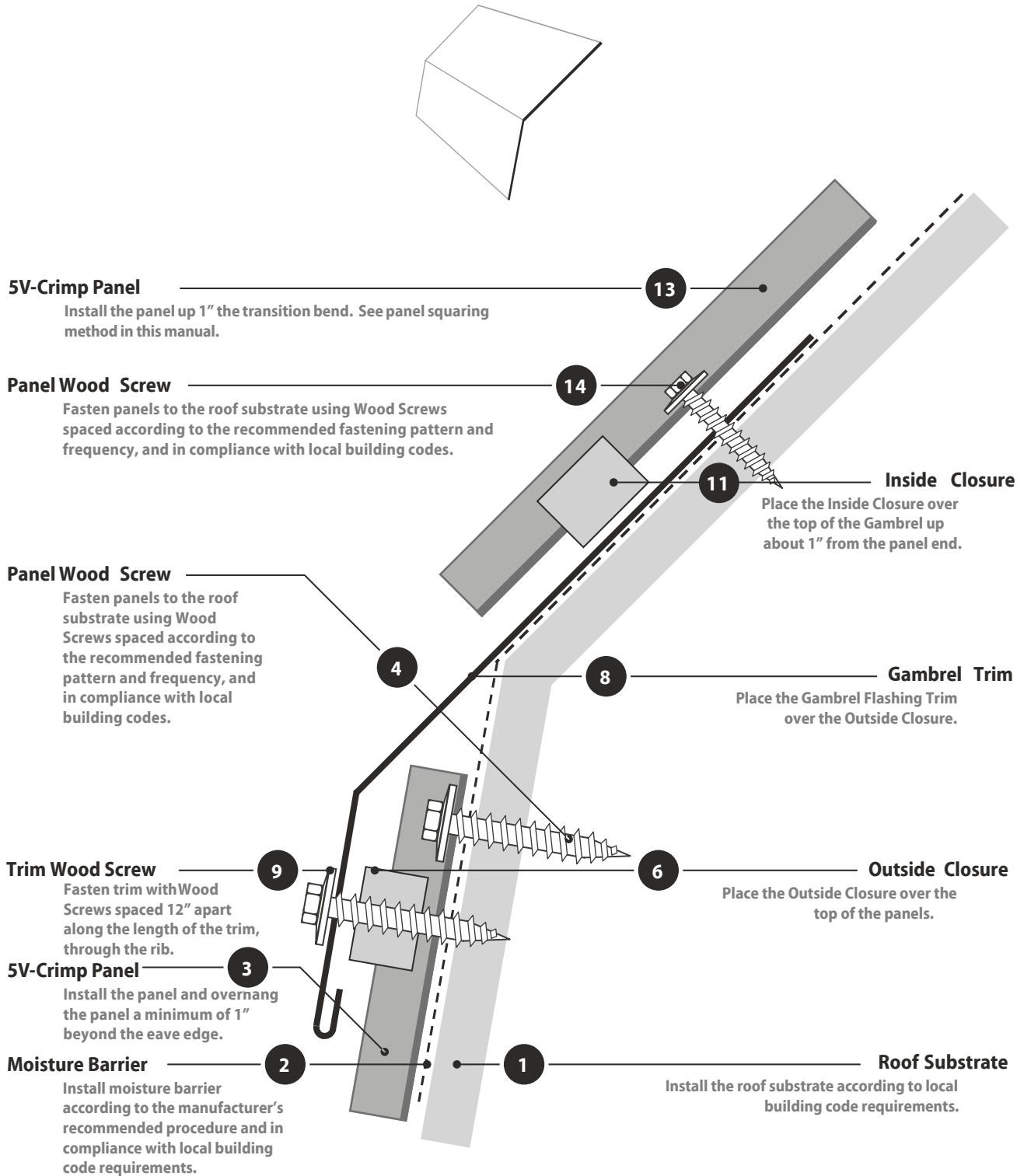

Hip

Numbers indicate suggested trim assembly sequence.

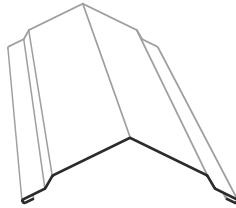

Panel Wood Screw

Fasten trim with Wood Screws spaced about 12" apart along the length of the trim, through the rib. See lapping diagram fastener pattern in this manual.

Hip Trim

Place the Hip Trim over the Expanding Closure

Expanding Closure

Place Expanding closure parallel to each side of the hip center line so that hip fastener penetrates the center of the closure. Closure should be up from the panel end about 1".

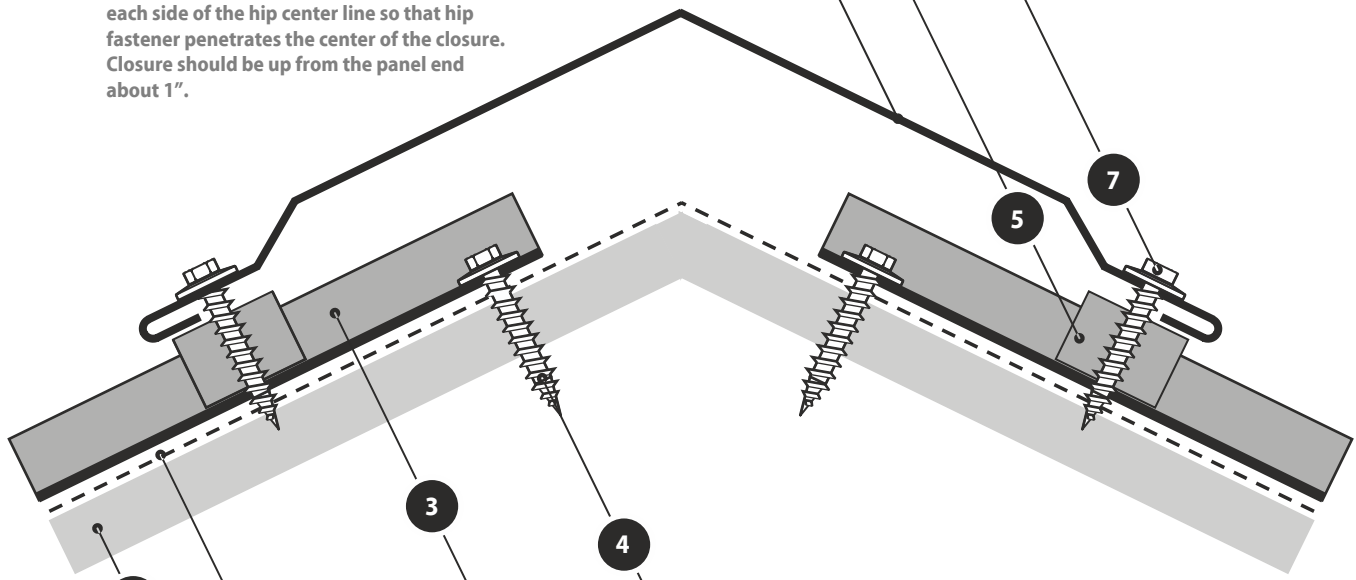

Panel Wood Screw

Fasten panels to the roof substrate using Wood Screws spaced according to the recommended fastening pattern and frequency, and in compliance with local building codes.

5V-Crimp Panel

Install the panel and overhang the panel a minimum of 1" beyond the eave edge. See panel squaring method in this manual.

Moisture Barrier

Install moisture barrier according to the manufacture's recommended procedure and in compliance with local building code requirements.

Roof Substrate

Install the roof substrate according to local building code requirements.

Ridge

Numbers indicate suggested trim assembly sequence.

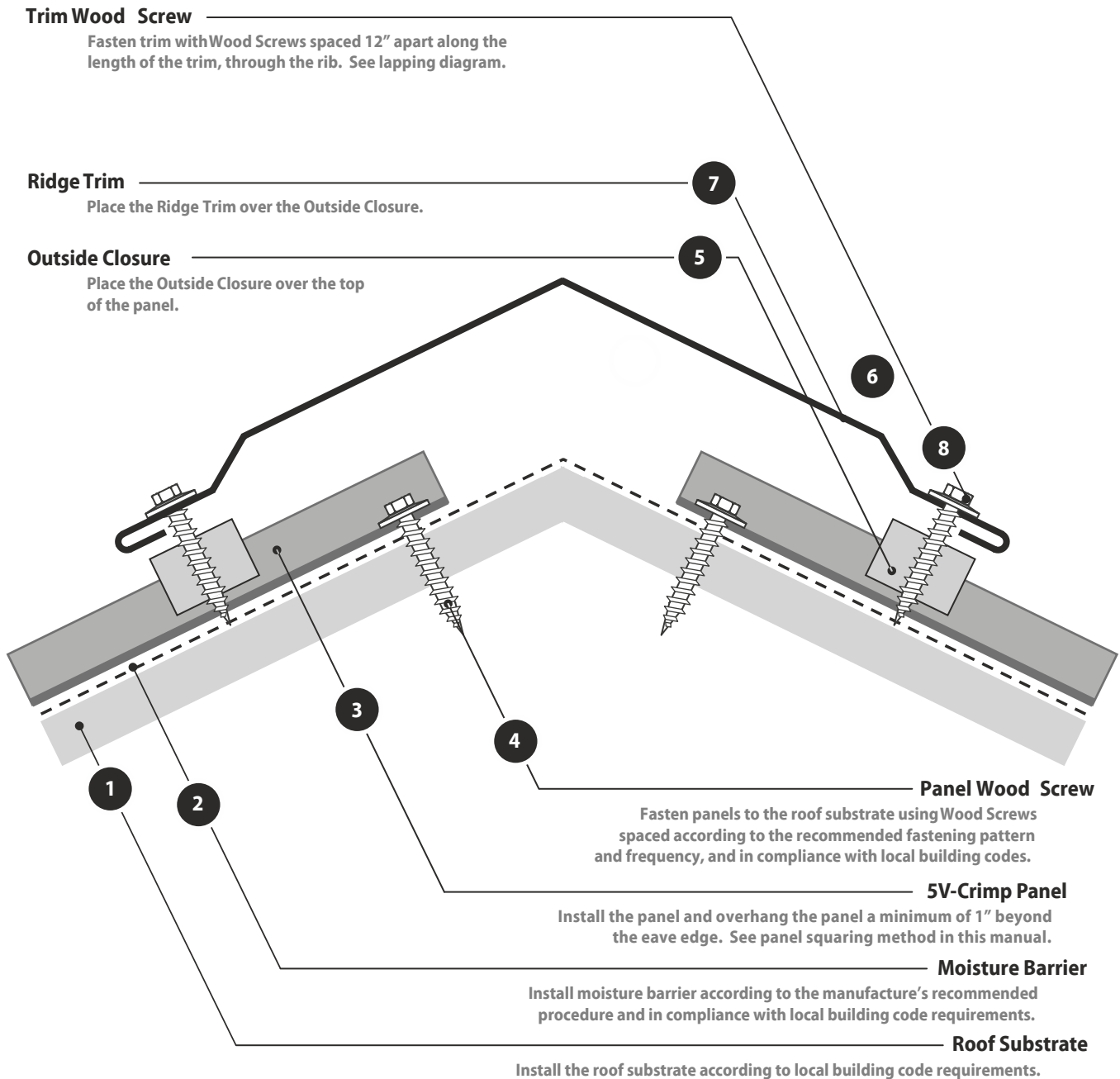
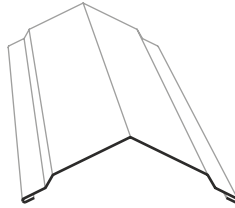

Vented Ridge

Numbers indicate suggested trim assembly sequence.

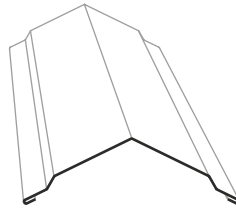

Trim Wood Screw

Fasten trim with Wood Screws spaced 12" apart along the length of the trim, through the rib. See lapping diagram fastener pattern in this manual.

Ridge Trim

Place the Ridge Trim over the Profile Vent.

Vent Material

Apply the Profile Vent ridge venting material over the panels on each side.

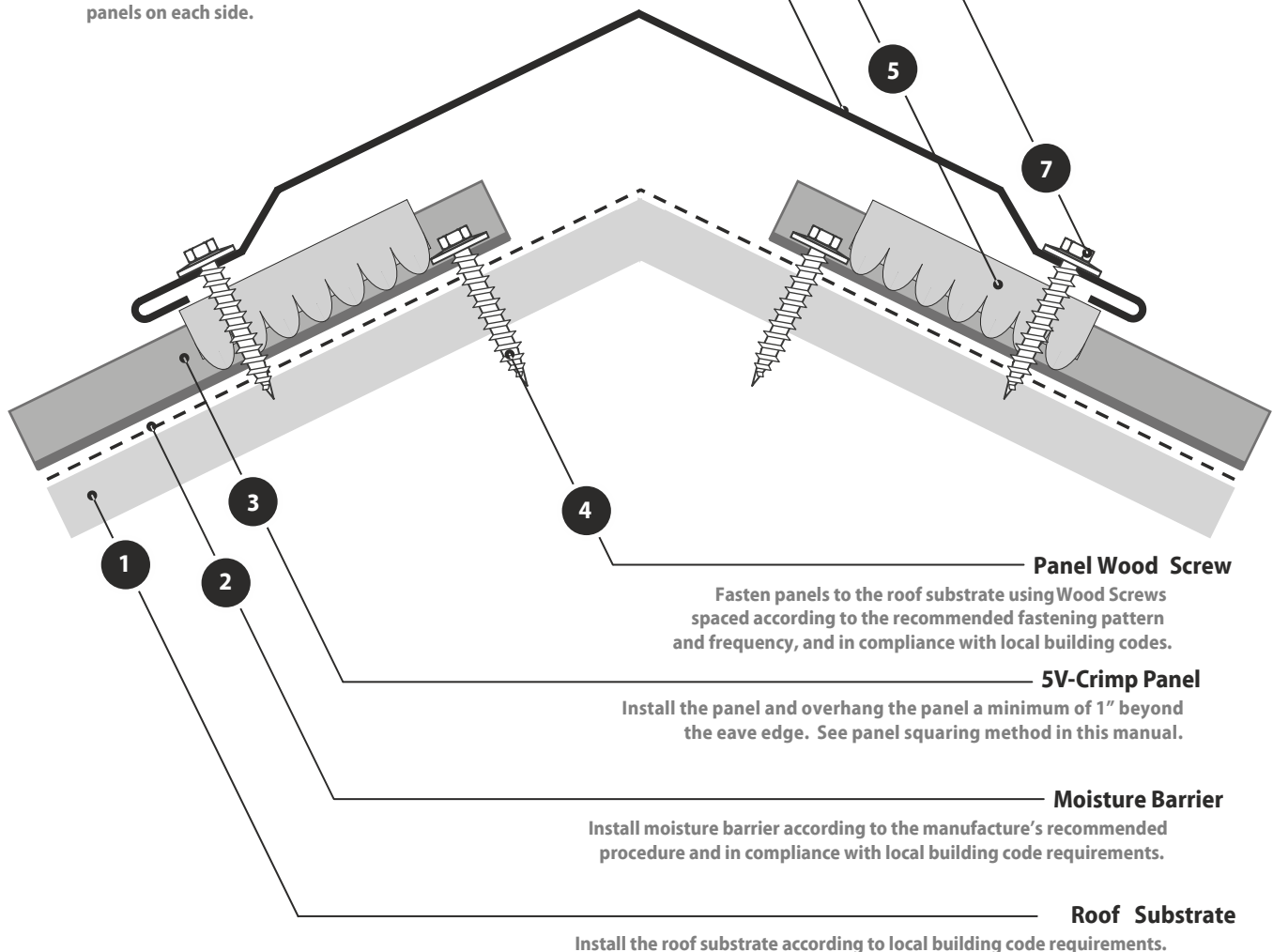

Panel Wood Screw

Fasten panels to the roof substrate using Wood Screws spaced according to the recommended fastening pattern and frequency, and in compliance with local building codes.

5V-Crimp Panel

Install the panel and overhang the panel a minimum of 1" beyond the eave edge. See panel squaring method in this manual.

Moisture Barrier

Install moisture barrier according to the manufacturer's recommended procedure and in compliance with local building code requirements.

Roof Substrate

Install the roof substrate according to local building code requirements.

High Side Peak

Numbers indicate suggested trim assembly sequence.

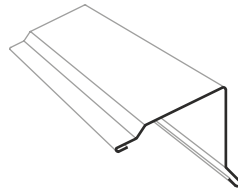

Trim Wood Screw

Fasten trim with Wood Screws spaced 2' apart along the length of the trim. See lapping diagram.

High Side Peak Trim

Place the High Side Peak Trim over the Outside Closure.

Trim Wood Screw

Fasten trim with Wood Screws spaced 12" apart along the length of the trim, through the rib. See lapping diagram.

Outside Closure

Place the Outside Closure over the panels.

Panel Wood Screw

Fasten panels to the roof substrate using Wood Screws spaced according to the recommended fastening pattern and frequency, and in compliance with local building codes.

5V-Crimp Panel

Install the panel and overhang the panel a minimum of 1" beyond the eave edge. See panel squaring method in this manual.

Moisture Barrier

Install moisture barrier according to the manufacturer's recommended procedure and in compliance with local building code requirements.

Roof Substrate

Install the roof substrate according to local building code requirements.

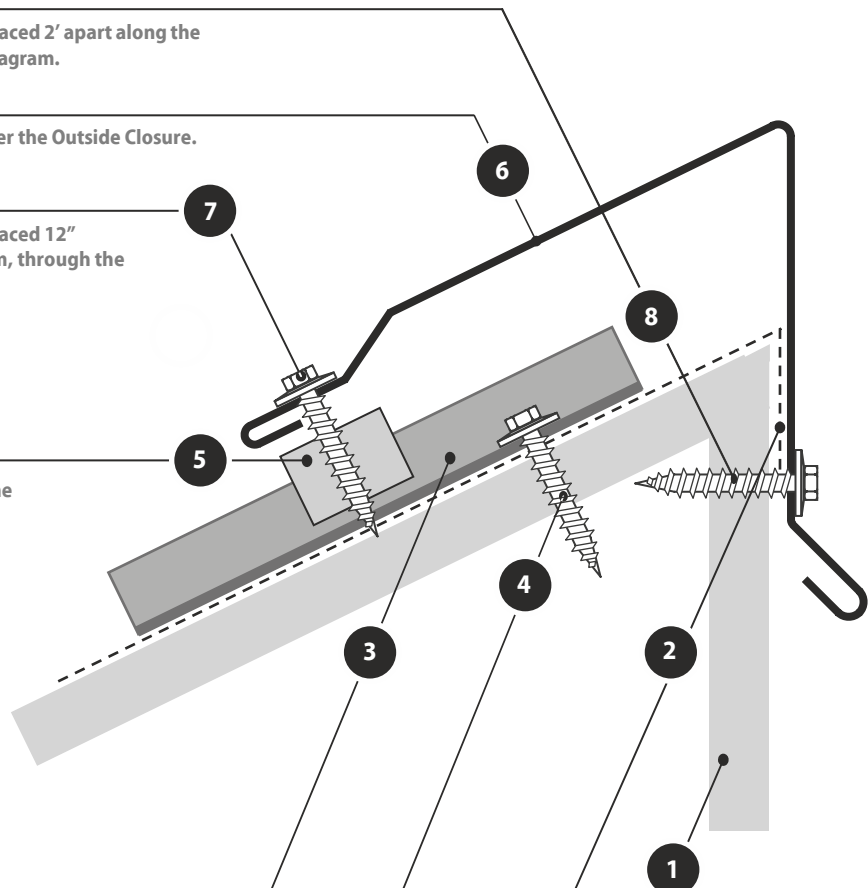

Side Wall

Numbers indicate suggested trim assembly sequence.

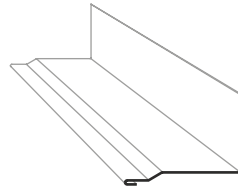

Tube Sealant

Apply Tube Sealant continuously along the Counter Flashing and generously filling the space between the flashing and the wall. Round or slope the Sealant top so that water will run off.

Trim Wood Screw

Fasten trim with Wood Screws spaced 2' apart along the length of the trim. If wall material is not wood, fasteners will be

Counter Flashing (optional)

Position the Counter Flashing above the Side Wall Trim as shown. Some applications may not need counter flashing.

Side Wall Trim

Place the Side Wall Trim over the Butyl tape and overlap the ends 4". See lapping diagram in this manual.

Trim Wood Screw

Fasten trim with Wood Screws spaced 2' apart along the length of the trim. See lapping diagram.

Tape Sealant

Apply Butyl Tape along the length of the panel.

Panel Wood Screw

Fasten panels to the roof substrate using Wood Screws spaced according to the recommended fastening pattern and frequency, and in compliance with local building codes.

5V-Crimp Panel

Install the panel and overhang the panel a minimum of 1" beyond the eave edge. See panel squaring method in this manual.

Moisture Barrier

Install moisture barrier according to the manufacturer's recommended procedure and in compliance with local building code requirements.

Roof Substrate

Install the roof substrate according to local building code requirements.

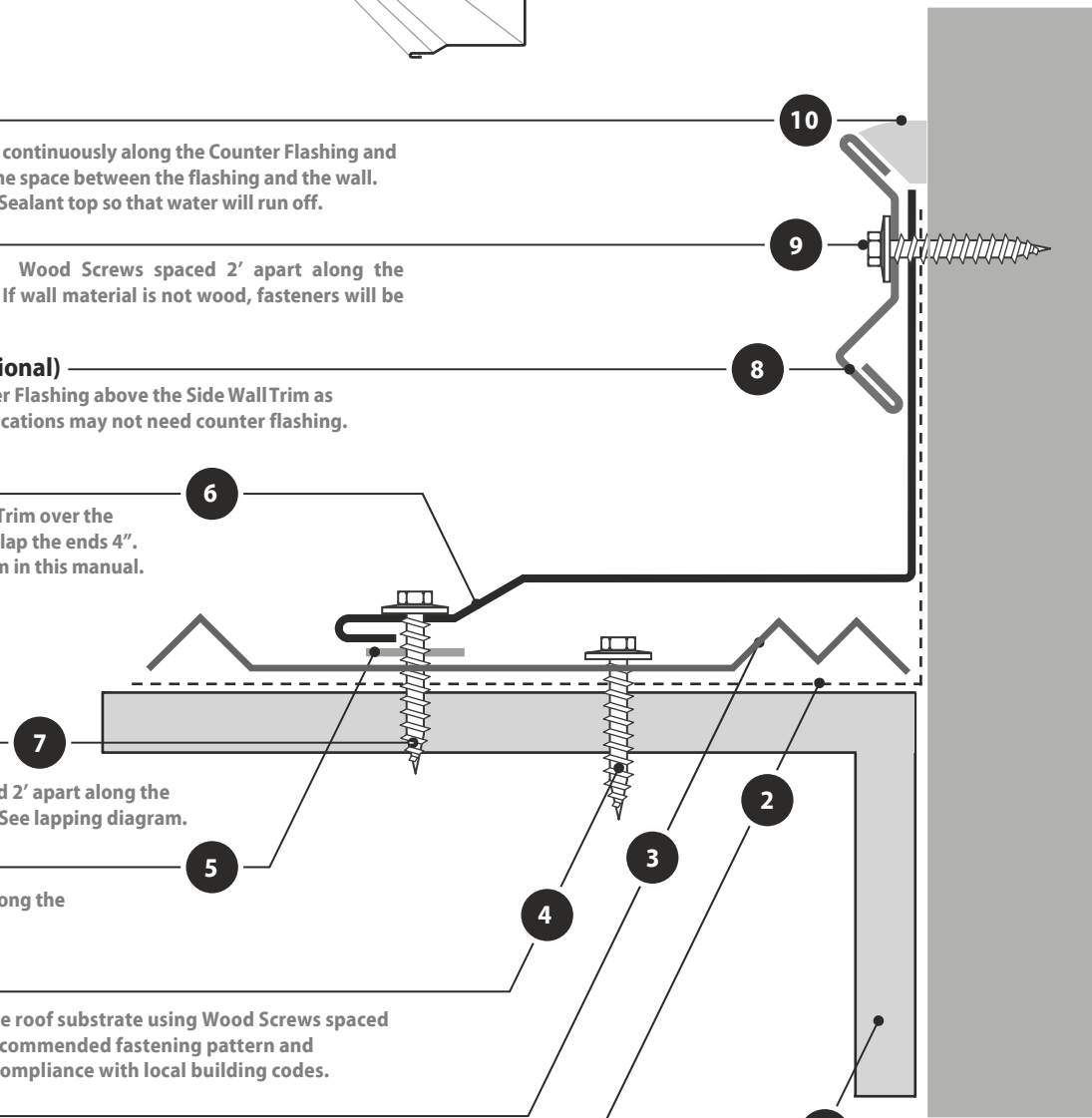

End Wall

Numbers indicate suggested trim assembly sequence.

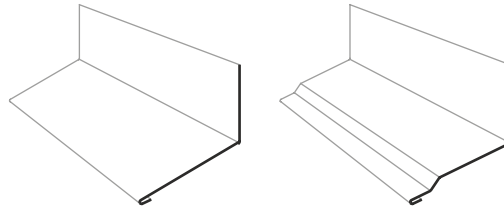

Tube Sealant

Apply Tube Sealant continuously along the Counter Flashing and generously filling the space between the flashing and the wall. Round or slope the Sealant top so that water will run off.

Trim Wood Screw

Fasten trim with Wood Screws spaced 2' apart along the length of the trim. If wall material is not wood, fasteners will be by others.

Counter Flashing

Position the Counter Flashing above the Side Wall Trim as shown. Some applications may not need counter flashing.

Side Wall Trim

Place the End Wall Trim over the Butyl tape and overlap the ends 4". See lapping diagram in this manual.

Outside Closure

Place the Outside Closure over the top of the panel.

Trim Wood Screw

Fasten trim with Wood Screws spaced 12" apart along the length of the trim, through the rib. See lapping diagram.

5V-Crimp Panel

Install the panel and overhang the panel a minimum of 1" beyond the eave edge. See panel squaring method in this manual.

Moisture Barrier

Install moisture barrier according to the manufacturer's recommended procedure.

Roof Substrate

Install the roof substrate according to local building code requirements.

Panel Wood Screw

Fasten panels to the roof substrate using Wood Screws spaced according to the recommended fastening pattern and frequency, and in compliance with local building codes.

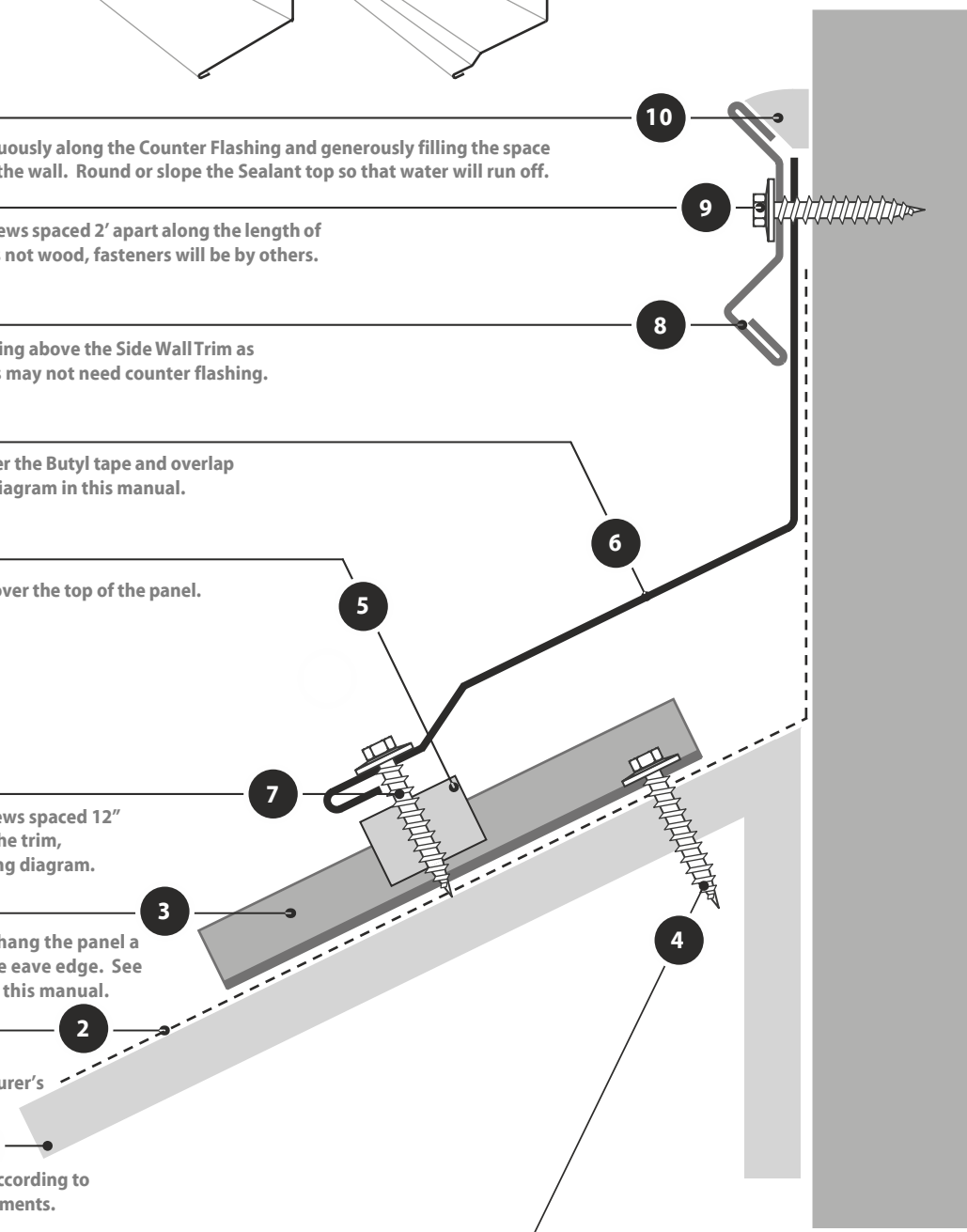

Trims

(Exact trims vary by plant, please call for exact dimensions)

Mini Eave



Eave Trim

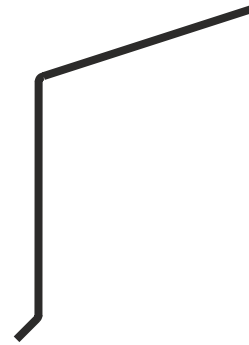

Fascia Trim



Rake / Gable Trim

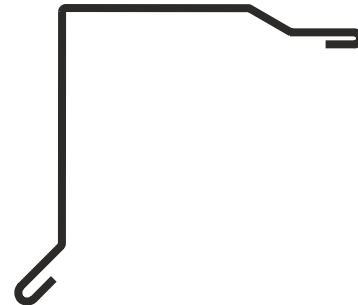

Valley



Transition Flashing

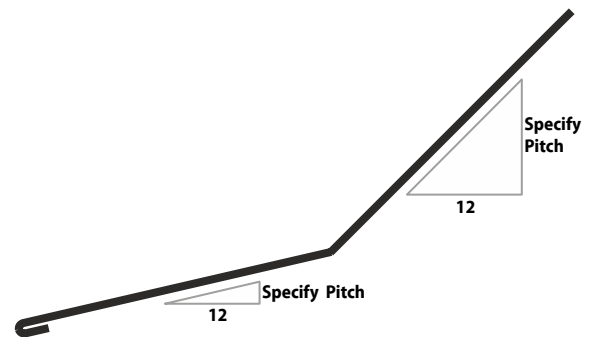

Trims

(Exact trims vary by plant, please call for exact dimensions)

Gambrel Flashing

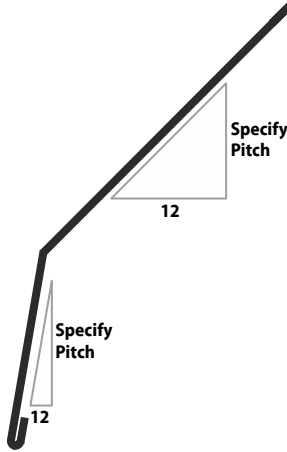

Ridge Cap / Hip Cap

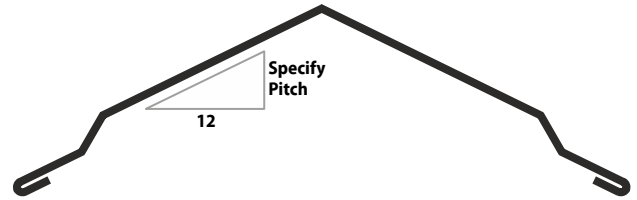

High Side Peak

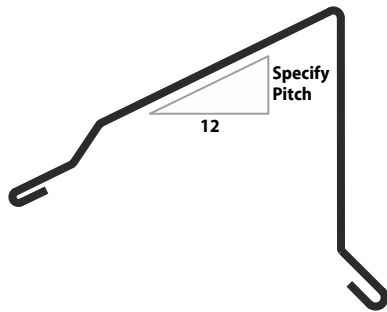

Side Wall Trim

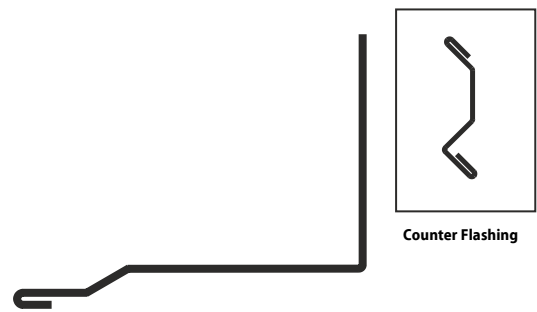

End Wall Trim

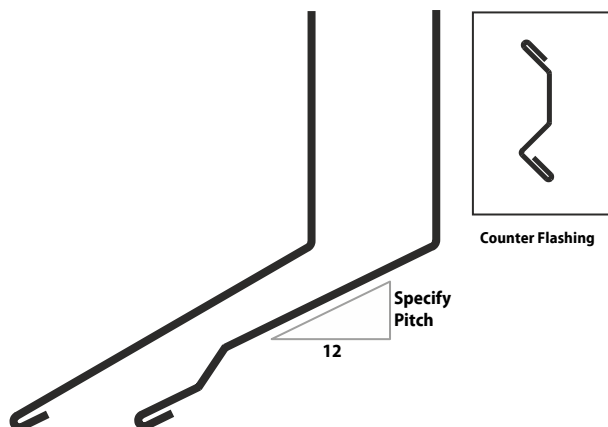

Accessories & Tools



Foam Closures
Fill In Upper And
Lower Panel Ends



Expanding Closures
Expands To Fill Ends
At Hips & Valleys



Profile Ridge Vent
Allows Hot Air To Vent
From Ridges



Fasteners
Screws, Pop Rivets,
Pancake Screws



Tube & Butyl Sealant
To Meet All Your
Sealing Needs

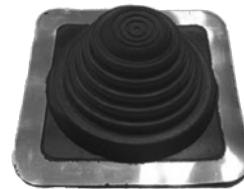

Pipe Boots
Flashes Pipes
Electric Boots Available



TurboShear HD
Shear Attachment
for Power Drill



Long Nose Snips
Great for
Cutting Panels



Rubber Coated Gloves
For Protection &
Slip Resistance



Drivers & Drill Bits



**Hemming, Bending,
& Turn Up Tools**



Pop Rivet Gun

Valley Lapping

↓ After cutting notches and applying Tube Sealant, slide the up slope valley into the hem groove while lapping over the top of the low slope valley 4". ↓

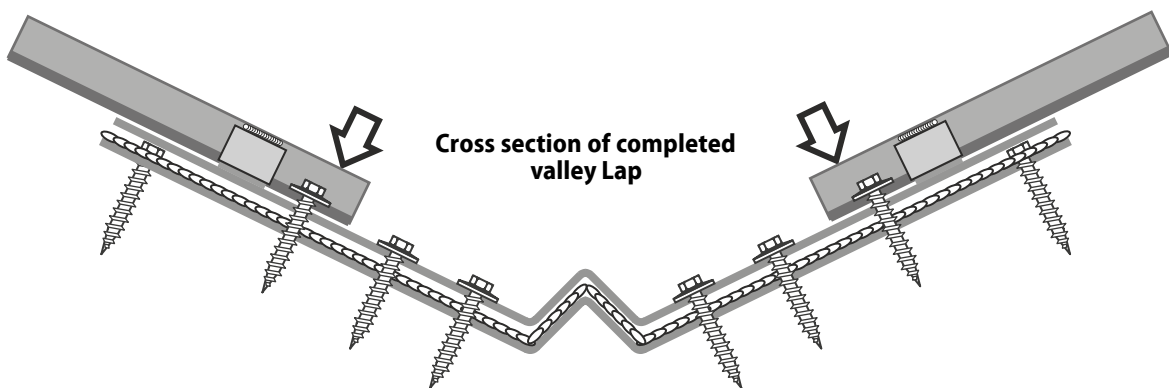
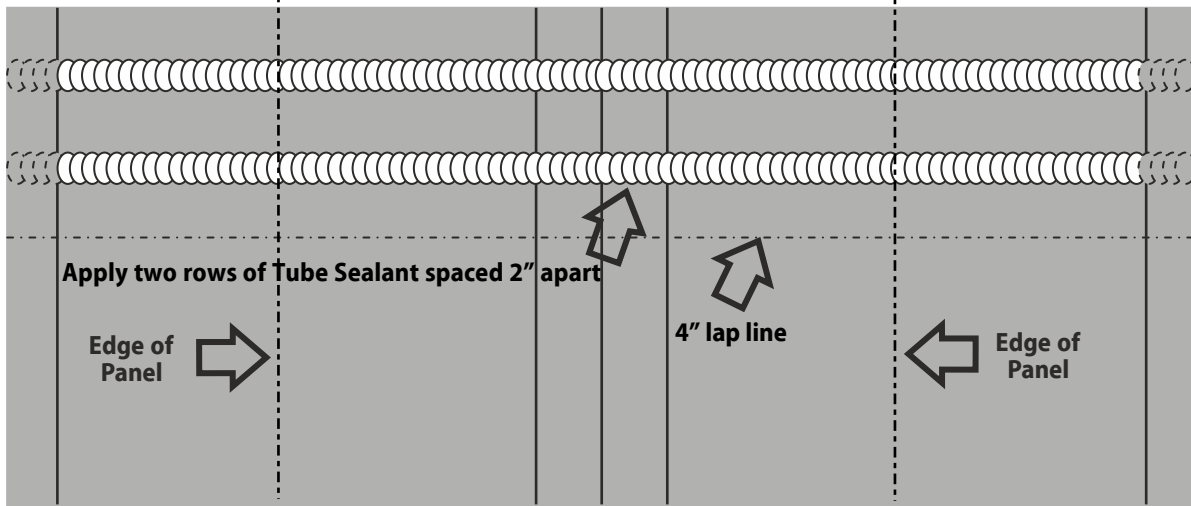
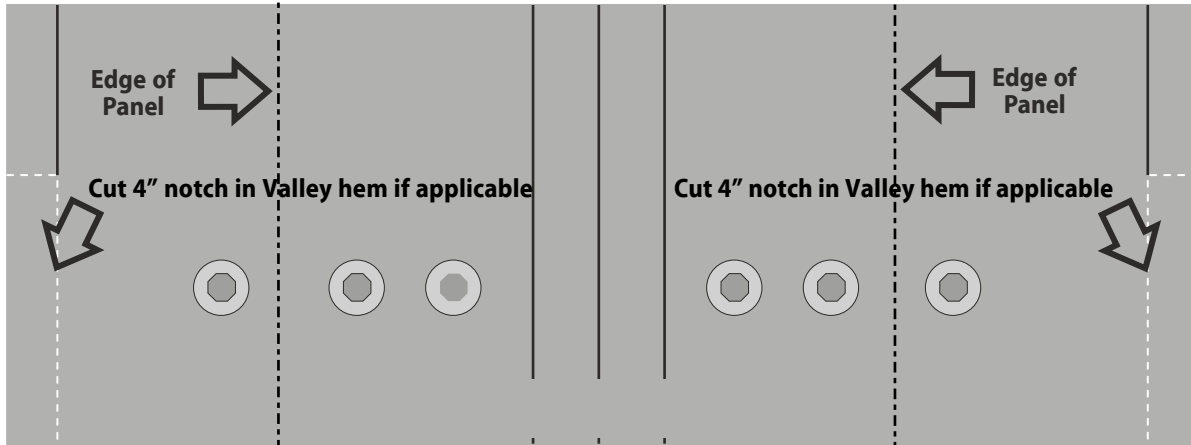

Valley Cutting

Valley starter cutting diagram with water diverter tabs.

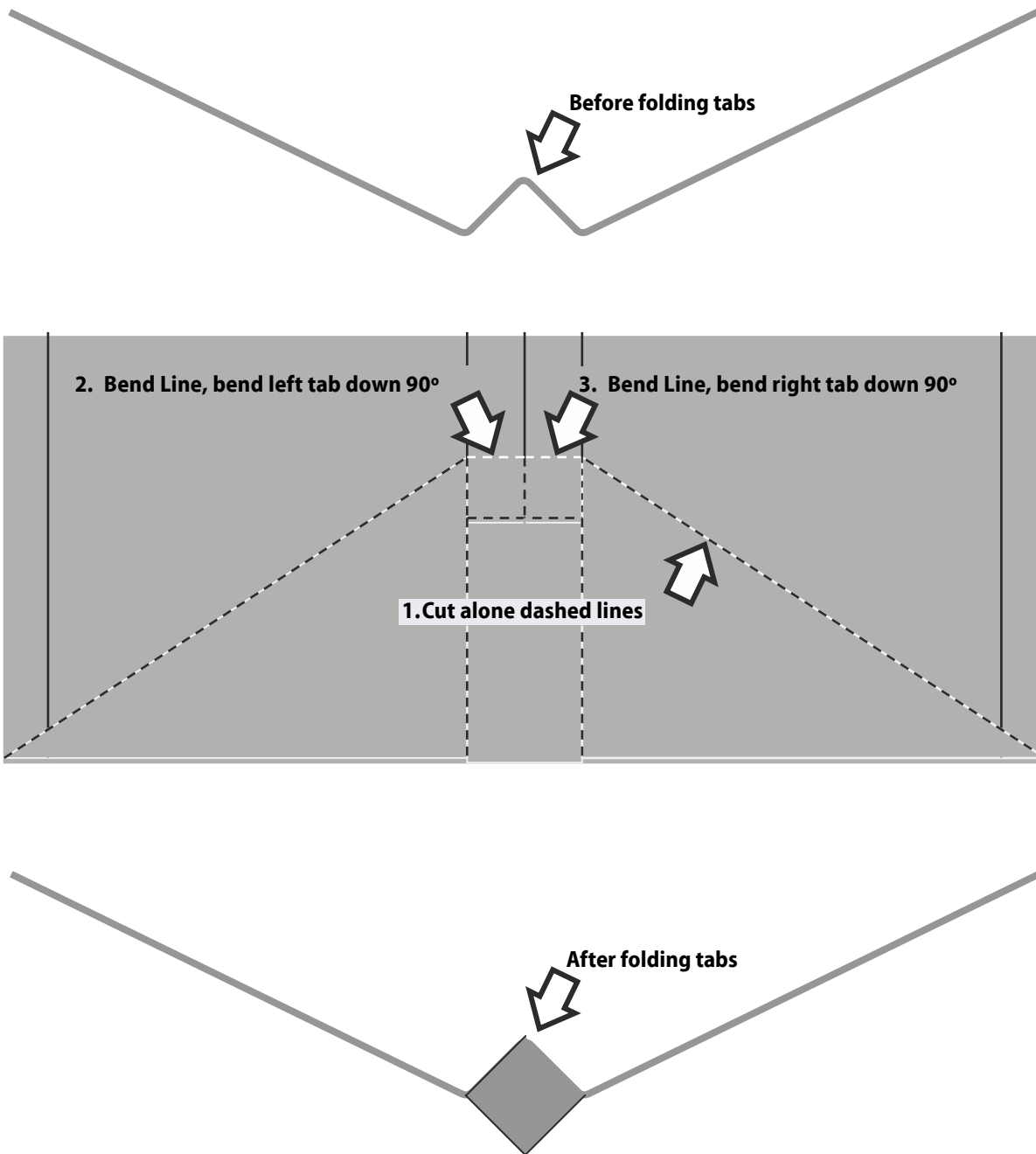

PIPE FLASHING

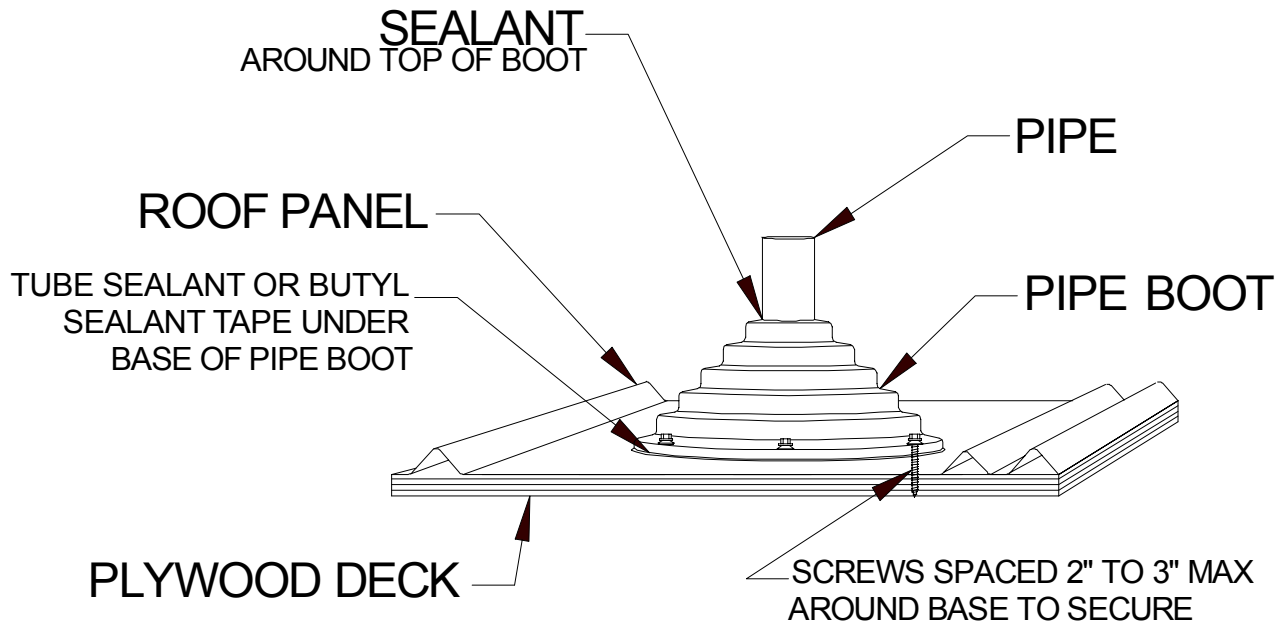

Notes:

1. Cut the hole in the flashing 20% smaller than the pipe diameter.
2. Slide the flashing down the pipe.
3. Form the flashing base to conform to the roof profile.
4. Apply sealant around the perimeter of the underside of the flashing base and fasten to the roof using 1"-1.5" woodscrews or 3/4"-7/8" stitch screws.



1652 S Lee Hwy • Cleveland, TN 37311 • 800-728-4010 • FAX: 423-728-3066